



## GameSaver® SILVER



Registering your appliance is quick and easy at [www.foodsaver.com/register](http://www.foodsaver.com/register). If you register on our website, you will have the opportunity to receive special bag and accessory introductory offers. Refer to the registration card inside the box.

For important safety information and helpful tips, please visit us at [www.foodsaver.com](http://www.foodsaver.com) to get tips on vacuum sealing and order FoodSaver® brand accessories, bags and rolls, or call 1-877-777-8042 (U.S.).



# User Manual

©2012 Sunbeam Products, Inc. doing business as Jarden Consumer Solutions. All rights reserved. Distributed by Sunbeam Products, Inc. doing business as Jarden Consumer Solutions, Boca Raton, Florida 33431.

## IMPORTANT SAFEGUARDS & TIPS

### Important Safeguards

**For your own safety, always follow these basic precautions when using a FoodSaver™ appliance:**

1. Read the User Manual carefully for operating instructions. Read all instructions in this manual before use.
2. Do not use appliance on wet or hot surfaces, or near a heat source.
3. To protect against electric shock, do not immerse any part of appliance, power cord or plug in water or other liquid. Unplug from outlet when not in use and before cleaning.
4. To disconnect, unplug power cord from electrical outlet. Do not disconnect by pulling on cord.
5. Do not operate appliance with a damaged power cord or plug. Do not operate appliance if it malfunctions or is in any way damaged. For details, contact Consumer Services at number listed below.
6. Use appliance only for its intended use.
7. Closely supervise children when using any electrical appliance. Do not allow appliance to be used as a toy.
8. 120v Appliances Only: The FoodSaver® appliance has a polarized plug (one blade is wider than the other). To reduce risk of electrical shock, this plug is intended to fit in a polarized outlet only one way. If plug does not fit fully in the outlet, reverse plug. If it still does not fit, contact a qualified electrician. Do not modify plug in any way.
9. Caution: Do not use extension cord. Appliance power cord should not drape over counter or tabletop where cord can be tripped over or pulled on unintentionally, especially by children.
10. Do not place on or near a hot gas or electric burner, or heated oven. Extreme caution must be used when moving products containing hot liquids.
11. Extreme caution must be used when sealing bags with hot liquids.
12. Wait 20 seconds between seals to allow appliance to cool.
13. CAUTION: Do not use outdoors.

**For Household Use Only  
SAVE THESE INSTRUCTIONS**

### Important Tips

1. Vacuum packaging is NOT a substitute for the heat process of canning. Perishables still need to be refrigerated or frozen.
2. For best results, use only with FoodSaver® Bags, Containers and Accessories.
3. During the vacuum packaging process, small amounts of liquids, crumbs or food particles can be inadvertently pulled into the Vacuum Channel. Empty the Drip Tray after each use.
4. Avoid overfilling, always leave at least 3 inches of bag material between bag contents and top of bag. This allows room for the bag material to cinch tightly against the food and prevents the bag from pulling out of the vacuum channel during the sealing process. Then leave at least one additional inch of bag material for each time you plan to reuse bag.
5. Do not create your own side seams for a FoodSaver® Bag. These bags are manufactured with a special side seam, which is sealed all the way to the outer edge.
6. To prevent wrinkles in the seal when vacuum packaging bulky items, gently stretch bag flat along Sealing Strip before you close lid.
7. When you are vacuum packaging items with sharp edges (dry spaghetti, silverware, etc.), protect bag from punctures by wrapping item in soft cushioning material, such as a paper towel. You may want to use a canister or Mason jar instead of a bag.
8. When using accessories, remember to leave one inch of space at top of canister or container.
9. Pre-freeze fruits and blanch vegetables before vacuum packaging for best results. See guidelines for Vacuum Packaging Section.

This appliance has a polarized plug (one blade is wider than the other). As a safety feature, this plug will fit in a polarized outlet only one way. If the plug does not fit fully in the outlet, reverse the plug. If it still does not fit, contact a qualified electrician. Do not attempt to defeat this safety feature.

## Welcome to the FoodSaver® GameSaver® System

### Congratulations...

*You are about to enjoy the freshness benefits of FoodSaver®, The #1 Selling Brand of Vacuum Packaging Systems. For years, the FoodSaver® Vacuum Packaging System has helped millions of households keep food fresh longer in the refrigerator, freezer and pantry. The FoodSaver® system is designed to remove air and extend freshness up to five times longer than conventional storage methods. Keep your FoodSaver® appliance on your countertop, and you'll soon discover its convenience and versatility.*

### Free Gift with Registration!

Register now and you'll receive a free gift. It's our "thanks" to you for being a FoodSaver customer.

Register online at [www.foodsaver.com/register](http://www.foodsaver.com/register). You'll have access to special sale items for online registrants only!

## Questions?

Contact customer service at  
**877-777-8042**  
or visit [www.foodsaver.com](http://www.foodsaver.com).

**Do not return this product  
to place of purchase.**

## Features of Your GameSaver® Appliance

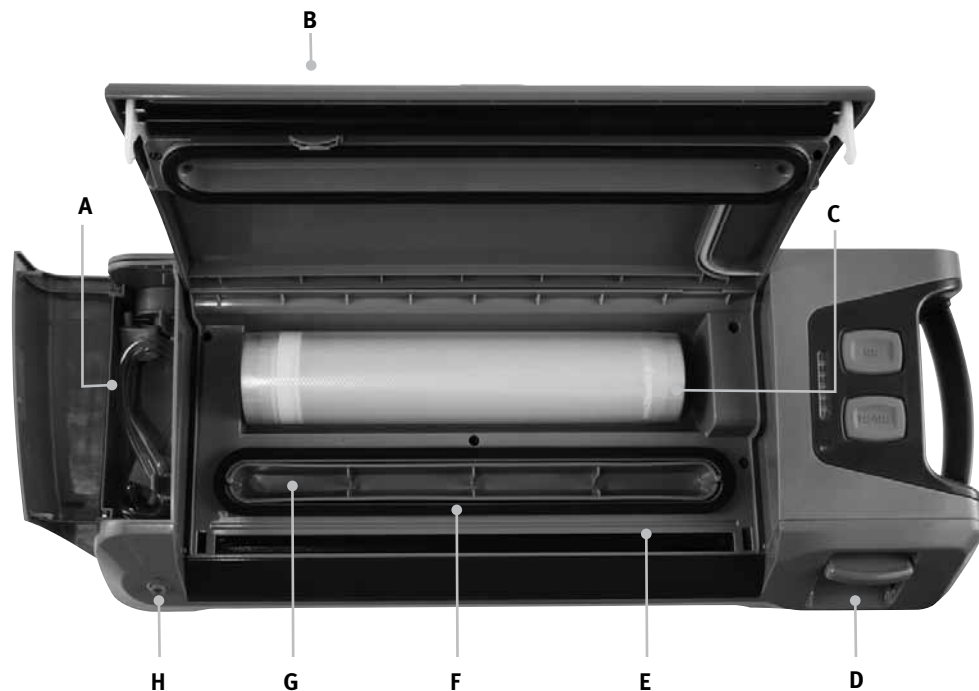

**A. Accessory Storage Compartment** – Stores Accessory Hose.

**B. Bag Cutter on Lid** – Simplifies making custom-sized bags

**C. Built-in Roll Holder** – For storage of FoodSaver® Vacuum Sealing Rolls

**D. Front Lid Latch** – Easily Open and Close unit; also has Store Position

**E. Sealing Strip** - Provides extra secure, airtight seal that's two times wider

**F. Foam Gasket** – make sure this is correctly positioned to ensure proper vacuum sealing

**G. Removable Drip Tray** – Large size helps to catch overflow liquids

**H. Accessory Hose Port** – Accessory hose can be used with all FoodSaver® Brand Accessories

## Features of Your GameSaver® Appliance

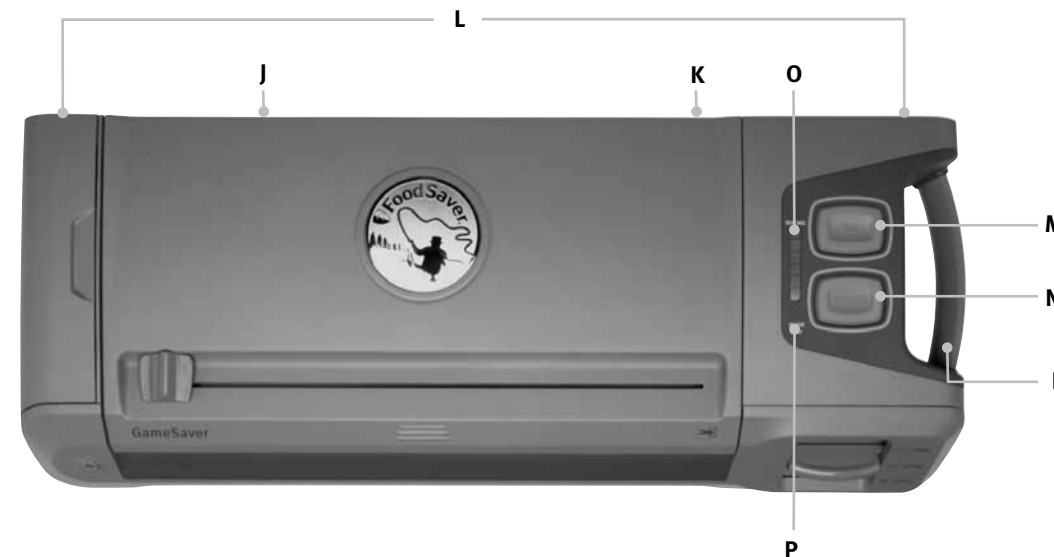

**I. Carry Handle** – Allows easy transportation of the appliance

**J. Power Cord Storage** – On back side of appliance

**K. 12V DC Adaptor Port** – Allows appliance to run off 12 Volt DC power

**L. Rubber Feet for Vertical Storage** – space-saving feature allows appliance to be stored vertically

**M. Seal Button** – The Seal button has three uses:

1. Press to create a seal when making bags from a FoodSaver® Roll.
2. Press to immediately stop the vacuum process and begin sealing the bag. This prevents crushing delicate items such as bread, cookies and pastries.
3. Press to create a seal on Mylar bags (such as a potato chip bag) to keep food sealed airtight.

**N. Vac/Seal Button** – Press to vacuum package and seal your food air-tight with a single touch. Shuts off automatically, Also can be used to pause the vacuuming cycle.

**O. Vacuum Progress Display** – Displays vacuum levels as the bag/canister is evacuated.

**P. Closed Light** - Comes on when latch is pushed down to Close position, which locks down the lid.

## 12 Volt Important Instructions

1. Make sure vehicle has a 10 amp rated fuse or higher. Refer to your vehicle's owners manual.
2. Plug 12 Volt DC adaptor into the appliance first.
3. Plug 12 Volt DC adaptor into the 12V power outlet.
4. When appliance is powered by 12 Volt DC, unit will take slightly longer to vacuum and seal than using standard 120 volt AC power.
5. Unit should be placed on flat surface and have enough room that the bag and its contents have surface support.

6. When appliance is powered by 12 Volt DC, make sure vehicle is running and all electrical items in vehicle are off (air conditioning, lights, radio, etc.).

**Note:** Do not plug unit into 12 Volt DC and 120 Volt wall outlet at the same time. Do not use any external supply not supplied with this appliance.

If green light on 12 Volt DC Adapter is not on, check the fuse on the Appliance Adapter and in Vehicle

**Warning:** Do not use the 12 Volt DC Adapter with the vehicle running in an enclosed space.

**Warning:** Use only Vehicle Adaptor KD-627 (E305658).

## How to Seal Only

If you want to seal a bag without vacuuming, use the Seal Button on the Control Panel. You can even reseal bags such as Mylar® potato chip bags.

1. Place open end of bag on Sealing Strip, close lid and use latch to lock.
2. Press Seal Button on Control Panel .

3. When Motor and Red Indicator Light turn off, unlock latch, open lid and remove bag.

**Note:** As long as you place open end of bag on Sealing Strip (not in Vacuum Channel), no air will be removed.

## How to Vacuum Package with FoodSaver® Accessories

1. Prepare container according to FoodSaver® Accessory Guidelines .
2. Insert one end of Accessory Hose into Accessory Port on appliance. Insert other end into port on accessory. Twist tab on Accessory Hose while inserting to ensure a tight fit.
3. Press Vac/Seal Button.
4. When motor and Indicator Light turn off, vacuum process is complete. Note that the appliance will still go through sealing cycle even when

vacuuming an accessory. You will hear Motor shut off and then the sealing cycle will begin.

5. Gently twist and remove Accessory Hose from accessory and appliance.

6. To test vacuum, simply tug on accessory lid. It should not move.

**Note:** For important tips on using accessories with different foods, please refer to the FoodSaver® Reference Guide.

## How to Open FoodSaver® Accessories after Vacuum Packaging

### FoodSaver Vacuum Packaging Canisters (without large knob on lid)

To release vacuum and open, push gray rubber button on lid.

### FoodSaver Bulk Canisters and Quick Marinators (with large knob on lid) and Universal Lids.

To release vacuum and open, turn knob on lid to Open.

### FoodSaver Jar Sealer with Mason Jars

For use with Ball® and Kerr® brand Mason jars.

**Important:** Do NOT use screw bands when vacuum packaging jars. To open, wedge spoon between Mason jar lid and highest part of threaded rim. Twist spoon gently to release vacuum.

### FoodSaver Bottle Stoppers

To release vacuum and open, twist and pull up on Bottle Stopper.

## How to Make a Bag from a FoodSaver® Vacuum Sealing Roll

1. Open Lid and pull bag material over the Sealing Strip.(Fig. 1)

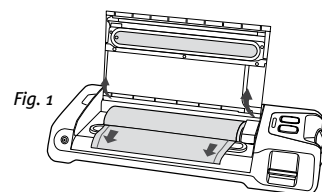

Fig. 1

2. Close and Latch Lid.(Fig.2)

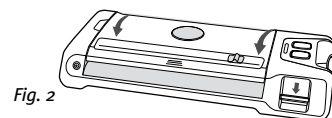

Fig. 2

3. Press Seal Button.(Fig.3)

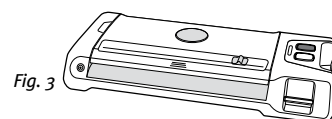

Fig. 3

4. When Red Progress Light turns off, sealing is complete. Unlock latch and lift lid.(Fig.4)

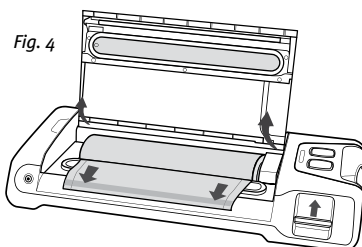

Fig. 4

5. Pull out desired bag length, Close Appliance Lid, and slide Bag Cutter across the roll. Make sure you leave 3" of space at top for room to vacuum seal. (Fig.5)

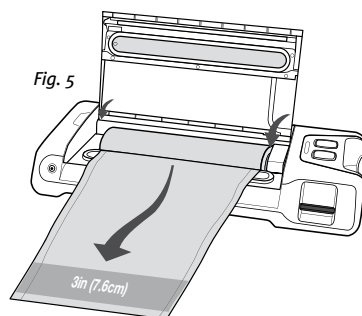

Fig. 5

## How to Vacuum Seal with FoodSaver® Vacuum Sealing Bags

1. Begin with a FoodSaver® Vacuum Sealing System Bag (or create a bag as described in the “How to Make a Bag from a Roll” section).

2. Place item(s) in bag, allowing at least 3 inches of space between bag contents and top of bag (Fig. 1). The extra space is required to allow the bag to seal tightly around contents.

Fig. 1

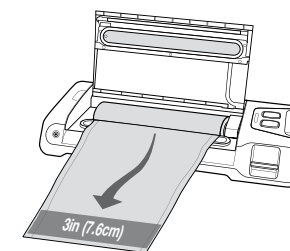

3. Open Appliance Lid and place open end of bag curl side down into the Drip Tray. (Fig. 2)

Fig. 2

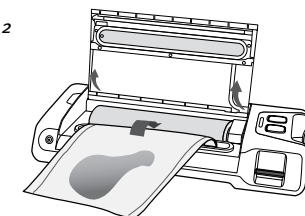

4. Close the Lid by pushing latch all the way down past the Store Position to the Closed Position. (Fig. 3).

Fig. 3

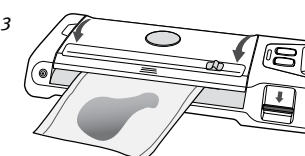

5. Press Vac/Seal Button (Fig. 4).

**Note:** To prevent crushing delicate items, you may press Seal Button at any time to begin sealing process. During vacuum process, you can press Vac/Seal Button to pause the process.

Fig. 4

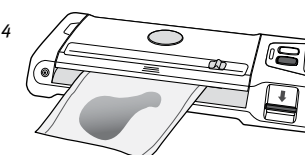

6. When the Red Indicator Light turns off, unlatch, lift lid, and remove bag. (Fig. 5)

Fig. 5

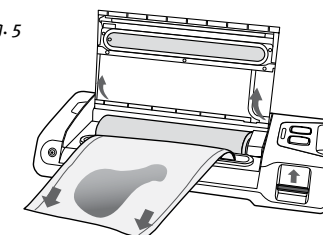

## Troubleshooting

Problem	Solution
Red Seal LED flashes	<ul style="list-style-type: none"> <li>• Unit is overheated, wait for 20 minutes for unit to cool down</li> <li>• If trying to seal an end of a roll to make a bag, make sure the bag is on the seal strip</li> <li>• If storing unit, make sure that latch is in Store position and not Closed position. If in Closed position for extended period of time the gaskets become compressed.</li> </ul>
Pump is running for more than 2 minutes without bag vacuuming (no visible air coming out of bag).	<ul style="list-style-type: none"> <li>• Make sure bag is inserted curl down in the vacuum channel.</li> <li>• Check to make sure top and bottom gaskets are inserted properly.</li> <li>• Check to make sure that at least one end of bag is sealed.</li> <li>• Open unit and check to make sure that there are no foreign objects, dirt or debris on the top or bottom gasket.</li> <li>• Make sure there is enough room at top of bag (3 inches) to fit to middle of drip tray with lid closed and latched.</li> <li>• Make sure accessory hose is not attached.</li> <li>• Make sure the lid is latched down all of the way.</li> </ul>
Bag is not sealing properly.	<ul style="list-style-type: none"> <li>• There is too much liquid in bag, freeze bag contents before vacuuming.</li> <li>• To prevent wrinkles in the seal, gently stretch bag flat while inserting bag into vacuum channel and continue to hold bag until vacuum pump starts.</li> <li>• Create a second seal above the first seal on the bag to ensure a proper seal when sealing moist foods.</li> </ul>
There are no lights on the control panel.	<ul style="list-style-type: none"> <li>• Make sure unit is plugged in.</li> <li>• Make sure wall outlet is functional.</li> <li>• Make sure latch is in Closed position.</li> </ul>
Nothing happens when latch is closed and Vac/Seal or Seal button is pressed.	<ul style="list-style-type: none"> <li>• Make sure unit is plugged in.</li> <li>• Make sure wall outlet is functional.</li> <li>• Open latch, make sure lid is all the way down, re-latch lid.</li> </ul>
DC Power is not working	<ul style="list-style-type: none"> <li>• Check if fuse in vehicle power outlet is working.</li> <li>• Battery of vehicle may be low- start vehicle motor.</li> <li>• Check if fuse in 12 Volt DC Adapter is working.</li> </ul>

## Tips for using Your FoodSaver GameSaver® Appliance

### Tips on Sealing a Bag

When making a bag from a roll, make sure end of cut piece is on Sealing Strip, not over rubber gasket or in Vacuum Channel.

Prevent moisture or liquid from being pulled into the Vacuum Channel or trapped in the seal. Either pre-freeze moist foods such as raw meat for

1–2 hours before vacuum packaging, or place a folded paper towel between food and end of bag to absorb excess liquids. Be sure to leave at least 3 inches between paper towel and end of bag so that bag seals properly with paper towel inside.

### Tips on Removing Air from a Bag

When vacuum packaging make sure open end of bag is inside Drip Tray with curl down. Also make sure roll itself is tucked back into Roll Storage Compartment or it could prevent appliance from operating properly.

Check for wrinkles in the bag along the Sealing Strip before closing lid and vacuum packaging. Wrinkles in seal may cause leakage and allow air to come back into bag. If you find wrinkles after sealing bag, simply cut bag open and vacuum package again.

If Motor runs for more than 30 seconds without stopping, you may need to adjust bag and try again. If you are making initial seal on a piece of bag material with two open ends, make sure you have pressed the Seal and not Vac/Seal Button. If you are vacuum packaging with a bag, make sure open end is placed down inside Vacuum Channel and make sure Accessory Hose is not attached. Also check that gasket is clean and free of debris. If you are vacuum packaging with an accessory, check Accessory Hose in appliance lid and in accessory to ensure a tight fit.

## Care and Cleaning

### To Clean Appliance:

Remove Power Cord from electrical outlet. Do not immerse in liquid.

Check Gaskets and around Drip Tray to make sure they are free from food materials. Wipe off gasket with warm soapy cloth if needed. Bottom gasket may be removed for cleaning. Clean with warm, soapy water. **The top gasket is not removable.**

The Removable Drip Tray makes cleanup easy when small amounts of liquids are inadvertently pulled into the Vacuum Channel during vacuum process.

Empty Drip Tray after each use. Wash in warm soapy water or place in top rack of dishwasher. Dry thoroughly before re-inserting into the appliance.

Always leave lid latch in open or store position, never leave in closed position. When appliance is left in closed position, the gaskets become compressed and the unit may not function properly.

Do not leave appliance outside in the environment while not in use.

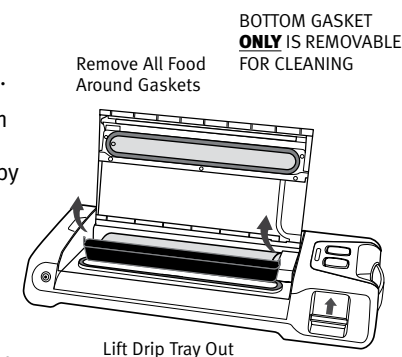

# Guidelines for Vacuum Packaging

## Vacuum Packaging and Food Safety

The vacuum packaging process extends the life of foods by removing most of the air from the sealed container, thereby reducing oxidation, which affects nutritional value, flavor and overall quality. Removing air can also inhibit growth of microorganisms, which can cause problems under certain conditions:

**Mold** – Easily identified by its fuzzy characteristic. Mold cannot grow in a low oxygen environment, therefore vacuum packaging can slow the growth of mold.

**Yeast** – Results in fermentation, which can be identified by smell and taste. Yeast needs water, sugar and a moderate temperature to grow. It can also survive with or without air. Slowing the growth of yeast requires refrigeration, while freezing stops it completely.

**Bacteria** – Results in an unpleasant odor, discoloration and/or soft or slimy texture. Under the right conditions, anaerobic bacteria such as Clostridium botulinum (the organism that causes Botulism) can grow without air and sometimes cannot be detected by smell or taste. Although it is extremely rare, it can be very dangerous.

To preserve foods safely, it is critical that you maintain low temperatures. You can significantly reduce the growth of microorganisms at temperatures of 40°F (4°C) or below. Freezing at 0°F (-17°C) does not kill microorganisms, but stops them from growing. For long-term storage, always freeze perishable foods that have been vacuum packaged, and keep refrigerated after thawing.

It is important to note that vacuum packaging is NOT a substitute for canning and it cannot reverse the deterioration of foods. It can only slow down the changes in quality. It is difficult to predict how long foods will retain their top-quality flavor, appearance or texture because it depends on age and condition of the food on the day it was vacuumed packaged.

**IMPORTANT: Vacuum packaging is NOT a substitute for refrigeration or freezing.** Any perishable foods that require refrigeration must still be refrigerated or frozen after vacuum packaging.

## Food Preparation and Reheating Tips

### Thawing and Reheating Vacuum Packaged Foods

Always thaw foods in either refrigerator or microwave — do not thaw perishable foods at room temperature.

To reheat foods in a microwave in a FoodSaver® Bag, always cut corner of the bag before placing it on a microwave-safe dish. However, to avoid hot spots, do not reheat bone-in meat or greasy foods in microwave within a FoodSaver® Bag. You can also reheat foods in FoodSaver® Bags by placing them in water at a low simmer below 170°F (75°C).

### Preparation Guidelines for Meat and Fish:

For best results, pre-freeze meat and fish for 1-2 hours before vacuum packaging in a FoodSaver® Bag. This helps retain the juice and shape, and guarantees a better seal.

If it's not possible to pre-freeze, place a folded paper towel between meat or fish and top of bag, but below seal area. Leave paper towel in bag to absorb excess moisture and juices during vacuum packaging process.

**Note:** Beef may appear darker after vacuum packaging due to the removal of oxygen. This is not an indication of spoilage.

### Preparation Guidelines for Hard Cheeses:

To keep cheese fresh, vacuum package it after each use. Make your FoodSaver® Bag extra long, allowing one inch of bag material for each time you plan to open and reseal in addition to the 3-inch room you normally leave between contents and seal. Simply cut sealed edge and remove cheese. When you're ready to repack the cheese, just drop it in bag and reseal.

**IMPORTANT: Due to the risk of anaerobic bacteria, Soft cheeses should never be vacuum packaged.**

### Preparation Guidelines for Vegetables:

Vegetables need to be blanched before vacuum packaging. This process stops the enzyme action that could lead to loss of flavor, color and texture.

To blanch vegetables, place them in boiling water or in the microwave until they are cooked, but still crisp. Blanching times range from 1 to 2 minutes for leafy greens and peas; 3 to 4 minutes for snap peas, sliced zucchini or broccoli; 5 minutes for carrots; and 7 to 11 minutes for corn on the cob. After blanching, immerse vegetables in cold water to stop the cooking process. Finally, dry vegetables on a towel before vacuum packaging.

**Note:** All vegetables (including broccoli, brussels sprouts, cabbage, cauliflower, kale, turnips) naturally emit gases during storage. Therefore, after blanching, they must be stored in freezer only.

When freezing vegetables, it is best to pre-freeze them for 1-2 hours or until solidly frozen. To freeze vegetables in individual servings, first place on a baking sheet and spread them out so they are not touching. This prevents them from freezing together in a block. Once they are frozen, remove from baking sheet and vacuum package vegetables in a FoodSaver® Bag. After they have been vacuum packaged, return them to the freezer.

**IMPORTANT: Due to the risk of anaerobic bacteria, Fresh mushrooms, onions, & garlic should never be vacuum packaged.**

### Preparation Guidelines for Leafy Vegetables:

For best results, use a canister to store leafy vegetables. First wash the vegetables, and then dry with a towel or salad spinner. After they are dried, put them in a canister and vacuum package. Store in refrigerator.

### Preparation Guidelines for Fruits:

When freezing soft fruits or berries, it is best to pre-freeze them for 1-2 hours or until solidly frozen. To freeze fruit in individual servings, first place on a baking sheet and spread them out so they are not touching. This prevents them from freezing together in a block. Once they are frozen, remove from baking sheet and vacuum package fruit in a FoodSaver® Bag. After they have been vacuum packaged, return them to the freezer.

You can vacuum package portions for baking, or in your favorite combinations for easy fruit salad all year round. If storing in the refrigerator, we recommend using a FoodSaver® Canister.

### Preparation Guidelines for Baked Goods:

To vacuum package soft or airy baked goods, we recommend using a FoodSaver® Canister so they will hold their shape. If using a bag, pre-freeze for 1-2 hours or until solidly frozen. To save time, make cookie dough, pie shells, whole pies, or mix dry ingredients in advance and vacuum package for later use.

### Preparation Guidelines for Coffee and Powdery Foods:

To prevent food particles from being drawn into vacuum pump, place a coffee filter or paper towel at top of bag or canister before vacuum packaging. You can also place the food in its original bag inside a FoodSaver® Bag, or use a FoodSaver® Universal Lid with the original container to vacuum package.

### Preparation Guidelines for Liquids:

Before you vacuum package liquids such as soup stock, pre-freeze in a casserole dish, loaf pan or ice cube tray until solid. Remove frozen liquid from pan and vacuum package in a FoodSaver® Bag. You can stack these “frozen bricks” in your freezer. When you're ready to use, just cut corner of bag and place in a dish in microwave or drop into water at a low simmer, below 170°F (75°C).

To vacuum package non-carbonated bottled liquids, you can use a FoodSaver® Bottle Stopper with the original container. Remember to leave at least one inch of room between contents and bottom of Bottle Stopper. You can re-seal bottles after each use.

### Preparation Guidelines for Make-ahead Meals, Leftovers and Sandwiches:

Efficiently store your make-ahead meals, leftovers and sandwiches in the stackable, lightweight FoodSaver® containers. They are microwaveable, top rack dishwasher safe and come with a custom adaptor. The lightweight containers will be ready to head off to the office or school when you are!

### Preparation Guidelines for Snack Foods:

Your snack foods will maintain their freshness longer when you vacuum package them. For best results, use a FoodSaver® Canister for crushable items like crackers.

## Vacuum Packaging Non-Food Items

The FoodSaver® vacuum packaging system also protects non-food items from oxidation, corrosion and moisture. Simply follow the directions to vacuum package items using FoodSaver® Bags, Canisters and Accessories.

To vacuum package silver, wrap fork tines in soft cushioning material, such as a paper towel, to avoid puncturing bag. Your FoodSaver® Bags are ideal for outdoor excursions. For camping and hiking, keep your matches, maps and food dry and compact. To have fresh water for drinking, simply fill a FoodSaver® Bag with ice, seal it and when needed, let the ice pack melt. If you're going sailing or boating, vacuum package your food, film and a dry change of clothes. Just remember to bring scissors or a knife to open the bag.

To keep emergency kits safe and dry, vacuum package flares, batteries, flashlights, matches, candles and other necessities. Your emergency items will stay dry and organized in your home, vehicle or boat.

## Storage Guide Meat, Cheese, Vegetables, Fruits

Foods	Where to Store	Recommended FoodSaver® Bag/Accessory	Storage Life with FoodSaver®	Normal Storage Life
<b>Meat</b>				
Beef, Pork, Lamb	Freezer	FoodSaver® Bag	2-3 years	6 months
Ground Meat	Freezer	FoodSaver® Bag	1 year	4 months
Poultry	Freezer	FoodSaver® Bag	2-3 years	6 months
Fish	Freezer	FoodSaver® Bag	2 years	6 months
<b>Hard Cheeses</b> ( Do not vacuum package soft cheese )				
Cheddar, Swiss	Refrigerator	FoodSaver Bag, Canister	4-8 months	1-2 weeks
Parmesan	Refrigerator	FoodSaver® Bag, Canister	4-8 months	1-2 weeks
<b>Vegetables</b> ( Do not vacuum package fresh mushrooms, onions & garlic )				
Asparagus	Freezer	FoodSaver® Bag	2-3 years	8 months
Broccoli, Cauliflower	Freezer	FoodSaver® Bag	2-3 years	8 months
Cabbage, Brussels Sprouts	Freezer	FoodSaver® Bag	2-3 years	8 months
Corn (cob or kernel)	Freezer	FoodSaver® Bag	2-3 years	8 months
Green Beans	Freezer	FoodSaver® Bag	2-3 years	8 months
Lettuce, Spinach	Refrigerator	FoodSaver® Canister	2 weeks	3-6 days
Snow Peas, Snap Peas	Freezer	FoodSaver® Bag	2-3 years	8 months
<b>Fruits</b>				
Apricots, Plums	Freezer	FoodSaver® Bag	1-3 years	6-12 months
Peaches, Nectarines	Freezer	FoodSaver® Bag	1-3 years	6-12 months
<b>Softer Berries</b>				
Raspberries, Blackberries	Refrigerator	FoodSaver® Canister	1 week	1-3 days
Strawberries	Refrigerator	FoodSaver® Canister	1 week	1-3 days
<b>Harder Berries</b>				
Blueberries	Refrigerator	FoodSaver® Canister	2 weeks	3-6 days
Cranberries	Refrigerator	FoodSaver® Canister	2 weeks	3-6 days
Huckleberries	Refrigerator	FoodSaver® Canister	2 weeks	3-6 days

## Storage Guide Baked Goods, Coffee, Snacks and Liquids

Foods	Where to Store	Recommended FoodSaver® Bag/Accessory	Storage life with FoodSaver®	Normal Storage Life
<b>Baked Goods</b>				
Bagels, Bread, Pastries	Freezer	FoodSaver® Bag	1-3 years	6-12 months
<b>Nuts</b>				
Almonds, Peanuts	Pantry	FoodSaver® Bag, Canister	2 years	6 months
Sunflower Seeds	Pantry	FoodSaver® Bag, Canister	2 years	6 months
<b>Coffee</b>				
Coffee Beans	Freezer	FoodSaver® Bag	2-3 years	6 months
Coffee Beans	Pantry	FoodSaver® Bag, Canister	1 year	3 months
Ground Coffee	Freezer	FoodSaver® Bag	2 years	6 months
Ground Coffee	Pantry	FoodSaver® Bag, Canister	5-6 months	1 month
<b>Prepared Liquids</b>				
Sauces, Soups, Stews	Freezer	FoodSaver® Bag	1-2 years	3-6 months
<b>Bottled Liquids</b>				
Oils	Pantry	FoodSaver® Bottle Stopper	1-1 1/2 years	5-6 months
<b>Dry Foods</b>				
Beans, Grains	Pantry	FoodSaver® Bag, Canister	1-2 years	6 months
Pasta, Rice	Pantry	FoodSaver® Bag, Canister	1-2 years	6 months
<b>Powdery Foods</b>				
Dry Milk	Pantry	FoodSaver® Bag, Canister	1-2 years	6 months
Dried Coconut	Pantry	FoodSaver® Bag, Canister	1-2 years	6 months
Flour	Pantry	FoodSaver® Bag, Canister	1-2 years	6 months
Sugar, Brown Sugar	Pantry	FoodSaver® Bag, Canister	1-2 years	6 months
<b>Snack Foods</b>				
Chips	Pantry	FoodSaver® Canister	3-6 weeks	1-2 weeks
Cookies, Crackers	Pantry	FoodSaver® Canister	3-6 weeks	1-2 weeks



## Recipes for your FoodSaver® Appliance

Go to [FoodSaver.com](http://FoodSaver.com)  
for more tips and recipes.

### Wild Rice & Almond-Stuffed Game Hens

¾ cup wild rice, cooked to package instructions	2 tablespoons butter
½ cup almonds, slivered	1½ cups beef broth
¼ cup shallots, minced	¾ cup dry red wine
½ teaspoon orange zest	1½ tablespoons Dijon mustard
2 - 1½ pound game hens, rinsed and dried	¾ teaspoon dried basil
	¼ teaspoon ground black pepper

Once the rice is cooked, stir in the almonds, shallots and orange zest. Stuff the dressing into the 2 prepared game hens. Melt butter and pour into Crock-Pot® slow cooker. In a separate pan, sear the game hens on all sides until brown. Place the browned game hens into the slow cooker. Whisk together the beef broth, red wine, Dijon mustard, basil and black pepper and pour over the game hens. Cover and cook on High for 4 to 5 hours or on Low for 6 to 8 hours. Drizzle the natural juices over the game hens to serve.

Serves 2

[www.crockpot.com](http://www.crockpot.com)

### Game Stew

2 lbs stew meat	1 tsp salt
½ c. flour	1 tsp sugar
3 Tbs shortening	1 tsp pepper
1 onion, chopped	½ tsp paprika
4 carrots, sliced	⅛ tsp cloves
1 tsp minced garlic	1 tsp lemon juice
2 bay leaves	1 tsp Worcestershire™
	4 c. water

Dredge meat in flour. Brown in shortening in skillet. Add to Crock-Pot® slow cooker with all other ingredients. Cover; cook on Low 10-12 hours or High 5-6 hours.

[www.crockpot.com](http://www.crockpot.com)

### Fresh Meat Jerky Recipe

#### Using Oster™ Jerky Seasonings to Make Jerky:

Jerky may be made from a variety of different meats. When selecting meats for making jerky, choose lean meats with minimal fat, as fat tends to go rancid during storage. A lean flank steak or round steak makes excellent jerky. Most lean meats will yield about 1 pound of jerky from every 2 pounds of fresh meat.

#### For Ground Meats:

Add both the spice mix and the cure mix of one Oster™ Jerky Seasonings packet to one pound extra lean ground beef, game, or poultry. For spicier jerky: add ¼ tsp. or more of cayenne pepper. For less spicy jerky, add ½ pound extra meat.

#### For Meats that are not Ground:

Remove all fat and cut into cubes or thin strips ¼" to ⅜" thick. It is easier to slice partially frozen meat for jerky. If meats are cut on the cross-wise grain, jerky is less chewy than if meats are cut on the lengthwise grain.

Mix Oster™ Jerky Seasonings and ¼ cup water well and put mix and meat in plastic storage bag to marinate for 6 to 8 hours in the refrigerator before drying.

#### Helpful Hints

- Do not overlap strips on dehydrator trays. Leave room between strips for air flow.
- Dry jerky until it has a tough "leather" texture, but is not brittle. Do not interrupt drying process or meat may spoil. For best results, rotate trays from top to bottom during the drying process.
- Depending on the thickness of the jerky strips, how much jerky is layered in the dehydrator and the humidity, it will take from 4 to 10 hours to dry. Pat jerky with clean paper towels several times as it dries to remove the oil which accumulates on the top of the jerky.
- After drying poultry, pork or fresh game, heat them in your oven at 160°F (71°C) for 30 minutes to avoid the risk of salmonella.
- Wrap jerky in paper towels and let it stand for a couple of hours prior to packaging.
- Beef jerky that is stored on the shelf will start to go rancid at room temperature after three to four weeks. Vacuum Package using your FoodSaver® GameSaver® Vacuum Sealing Appliance for freezer or refrigerator storage.

[www.oster.com](http://www.oster.com)

## Lifetime Limited Warranty

Sunbeam Products, Inc. doing business as Jarden Consumer Solutions, or if in Canada, Sunbeam Corporation (Canada) Limited doing business as Jarden Consumer Solutions (collectively “JCS”) warrants that from the date of purchase, this product will be free from defects in material and workmanship. This Limited Lifetime Warranty shall be effective from the of the original purchase date and shall expire five (5) years after the date the item has been discontinued or announced as discontinued (“Limited Lifetime Warranty Period”). JCS, at its option, will repair or replace this product or any component of the product found to be defective during the Limited Lifetime Warranty Period . A replacement will be made with a new or remanufactured product or component. If the product is no longer available a replacement may be made with a similar product of equal or greater value. This is your exclusive Limited Lifetime Warranty. Do NOT attempt to repair or adjust any electrical or mechanical functions on this product. Doing so will void this Limited Lifetime Warranty. This Limited Lifetime Warranty is valid for the original retail purchaser from the date of initial retail purchase and is not transferable. Keep the original sales receipt. Proof of purchase is required to obtain warranty performance.

JCS dealers, service centers, or retail stores selling JCS products do not have the right to alter, modify or any way change the terms and conditions of this Limited Lifetime Warranty. This Limited Lifetime Warranty does not cover normal wear of parts or damage resulting from any of the following: negligent use or misuse of the product, use on improper voltage or current, use contrary to the operating instructions, disassembly, repair or alteration by anyone other than JCS or an authorized JCS service center. Further, this Limited Lifetime Warranty does not cover: Acts of God, such as fire, flood, hurricanes and tornadoes.

### What are the limits on JCS’s Liability?

Damage to a product caused by accident, misuse, or abuse is not covered by this Limited Lifetime Warranty. Improper care and cleaning will void this Limited Lifetime Warranty. JCS shall not be liable for any incidental or consequential damages caused by the breach of any express, implied or statutory warranty or condition. Except to the extent prohibited by applicable law, any implied warranty or condition of merchantability or fitness for a particular purpose is limited in duration to the duration of the above warranty. JCS disclaims all other warranties, conditions or representations, express, implied, statutory or otherwise. JCS shall not be liable for any damages of any kind resulting from the purchase, use or misuse of, or inability to use the product including incidental, special, consequential or similar damages or loss of profits, or for any breach of contract, fundamental or otherwise, or for any claim brought against purchaser by any other party.

Some provinces, states or jurisdictions do not allow the exclusion or limitation of incidental or consequential damages or limitations on how long an implied warranty lasts, so the above limitations or exclusion may not apply to you.

This warranty gives you specific legal rights, and you may also have other rights that vary from province to province, state to state or jurisdiction to jurisdiction.

**PLEASE DO NOT RETURN THIS PRODUCT TO ANY OF THESE ADDRESSES OR TO THE PLACE OF PURCHASE.**

## Notes